

Installation Guidelines

FOR NEXT DIMENSION WINDOWS

Installer

- Read instructions completely before attempting installation. Failure to follow these guidelines will void the Windsor warranty coverage, written or implied. Windsor Windows & Doors will not be held responsible for any claims for damages resulting from installation.
- Always provide a copy of these instructions to the homeowner.
- These instructions are consistent with ASTM 2112 “Standard Practice for Installation of Exterior Windows, Doors and Skylights” into common wall constructions. For installation into air barrier sheathing systems such as ZIP System, refer to our supplemental installation instructions at www.windsorwindows.com. Contact your architect or construction professional for installation into other building designs or construction methods.
- Regional codes and environmental conditions may require installation that is different from these guidelines. It is your responsibility to ensure that local codes and ordinances are followed.

Warning

- ⚠ **Work Safe!** Always wear proper eye and hearing protection when installing or adjusting Windsor products.
- ⚠ **Use Power Tools Properly!** To avoid personal injury, always follow manufacturers' instructions for safe operation of power tools.
- ⚠ **Ladder Safety!** Working at elevated levels can be hazardous. Always use ladders and scaffolding properly. Consult manufacturers' guidelines for safe use of these types of equipment.
- ⚠ **Safety Glazing!** Windsor products do not contain safety glazing unless specifically ordered that way. Use caution – injury could result if glass is broken and fragmented. Building codes require safety glazing for windows installed in certain areas. Consult your local building code official for guidelines.

Important

- Windsor reserves the right to change the information contained in these guidelines without notice.

- Maintain a minimum of 1/4" between the window frame and any trim, siding or masonry.
- **WARNING:** Use of Windsor products in barrier systems that lack a suitable exterior like siding, masonry, stucco, or EIFS with an engineered drainage system, will void all Windsor warranties, written or implied, and Windsor Windows & Doors will not be held responsible for any claims or damages resulting from the lack of a suitable exterior. The lack of a suitable exterior as described herein prevents application of proper perimeter sealant of the windows or door frame as required by Windsor's Installation Guidelines. Exterior membranes, liquid applied and otherwise, DO NOT qualify as a suitable exterior.
- Steel fasteners will corrode when used with ACQ pressure treated lumber. Use corrosion-resistant fasteners (such as stainless steel) when installing windows in or around these types of materials.
- Window nailing flanges and drip caps (integral or applied) do not take the place of window flashing. All windows and doors must be properly flashed and sealed around the perimeter.
- Certain Windsor double hung products are furnished with jamb jacks. Jamb jacks are not required for installation, but can be used after installation to adjust the frame width at the middle of the unit. Jamb jacks should not be used in place of shims. Refer to Step 5 for shimming guidelines.

Handling and Storage

- Always carry window units upright. Do not carry flat! Doing so could result in damage to the unit.
- Do not store units outside.
- **CAUTION: Prefinished Interiors:** Windows with prefinished interiors must be protected from dents, scratches, scrapes or other blemishes. Windsor does not warrant against dents, scratches, scrapes or other damage to prefinished interiors after the Windsor

products leave Windsor's possession. After the Windsor products leave Windsor's possession, extreme care must be taken by those moving the windows, or those working on or around the windows, to protect prefinished interiors from dents, scratches, scrapes or other blemishes.

IMPORTANT! IF VINYL WINDOWS AND DOORS ARE NOT INSTALLED IMMEDIATELY UPON DELIVERY, THEY MUST BE PROPERLY STORED AND PROTECTED UNTIL INSTALLED. If the vinyl product is not stored properly, distortion of the frames can occur affecting operation and performance. Vinyl windows and doors should be installed within 30-60 days of receiving.

Follow these procedures for proper storage of vinyl windows and doors:

- **Remove stretch wrap immediately so the individual units can be exposed to circulated air.**
- **Do not store units outside or in direct sunlight. Allow sufficient spacing between products for ventilation.**
- **Never store vinyl units in a closed truck or other similar enclosure where the units can get too hot.**
- **Never stack or lean vinyl units against each other in the sun.**
- **Always carry vinyl units upright. Do not carry flat! Doing so can result in damage to the unit.**
- **Always store vinyl units vertically. Do not store windows flat or stack horizontally.**
- **Vinyl units must be stored in a clean, dry, well-ventilated area where they will be protected from the elements.**
- **Vinyl windows with unsupported nailing fins should have their corners blocked and protected to prevent damage to the nailing fin.**

Failure to follow these procedures will void our product warranty.

Tools Needed

- Safety Glasses



- Ladder / Scaffolding



- Utility Knife



- Square



- Hammer (or nail gun)



- Tape Measure



- Caulk Gun



- Stapler



- Level



Materials Needed

- Backer Rod
 - 1/4"-1/2" diameter closed cell foam
- Insulation
 - Minimally expanding low pressure polyurethane window and door foam
- Shims
 - Made of cedar or synthetic material
- Roofing Nails
 - 11 ga. x 2-1/2" galvanized
- Silicone Sealant
 - 100% Silicone
 - Neutral cure (modified oxime) only
- Flashing
 - Self-adhesive flexible flashing that complies with AAMA-711

LEAD PAINT AND EXISTING WINDOW DISPOSAL:

- A) Before any remodel or renovation, make sure to identify any potential lead paint issues and take necessary steps to reduce the risk of lead contamination.
- B) The U.S. Environmental Protection Agency (EPA) has issued a "Lead Renovation, Repair and Painting Rule (RRP)" for remodelers of older homes and buildings. This rule requires training and certification in lead-safe work practices for firms performing renovation, repair or painting on homes and child-occupied facilities built prior to 1978.
- C) For more information regarding procedures for dealing with lead paint, please visit EPA's website at www.epa.gov/lead.
- D) When removing existing windows, make sure to wear appropriate personal protective equipment. Extra precautions should be taken to protect others and property within the vicinity and below the removal window and surrounding components.
- E) Consult with local waste authorities on the proper recycling or disposal of old window components.

ATTENTION! ARBITRATION AGREEMENT; JURY TRIAL WAIVER; CLASS ACTION WAIVER. By purchasing, installing or using this product, you agree to arbitrate any dispute you may have with Windsor relating to your Windsor products, and to waive your rights to a jury trial and to participate in class-action or class-arbitration proceedings, relating to any such disputes. For more details, and to learn how **YOU CAN OPT OUT OF THIS ARBITRATION AGREEMENT AND THESE WAIVERS**, please go to www.windsorwindows.com/support/Dispute-Resolution.

Step 1: Inspect Unit

Before Installation:

- A) Remove all shipping/packaging material (blocks, pads, protectors, stretch wrap).
- B) Inspect unit for any damage or defects.
- C) Verify that the window unit is the correct size and configuration.
- D) Make sure the unit operates properly.
- E) Contact the nearest Windsor distributor if there are any problems.

Step 2: Apply Jamb Extension Clips or Drywall Return

- A) Place a 1/8" diameter bead of 100% neutral cure sealant around the interior perimeter of the frame in the recess shown. (Fig. 1)
- B) Install the 3" jamb extension clips around the perimeter of the frame, two on each corner, and then spaced on approximately 18" intervals along the frame. (Fig. 2) **Note: For drywall return, install lineal pieces.**
- C) Position the jamb extension as shown against the clips and staple or screw through the clip into the backside of the jamb extension. (Fig. 2)
- D) Wrap jamb extension around the window as shown. (Fig. 3)

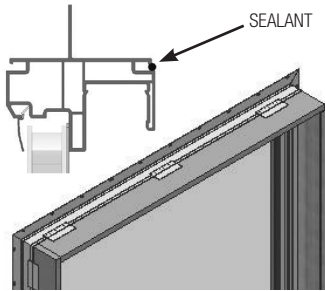

FIG. 1

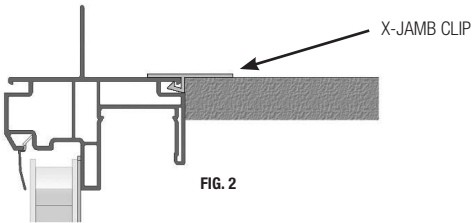

FIG. 2

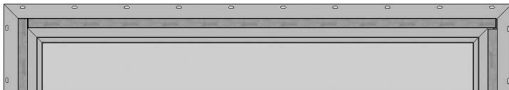

FIG. 3

Step 3: Prepare Rough Opening

- A) Measure and verify the size of the rough opening. The rough opening should be 1/2" larger than the frame in both width and height.
- B) Framing recommendations for radius and geometric windows are shown in (Fig. 3a)
- C) Verify the rough opening is flat, plumb, level and square. (Fig.4)
- D) Take diagonal measurements to check for square. (Fig. 4)
- E) Make sure the bottom sill area of the opening does not slope toward the interior.
- F) Make an "I-Cut" in the weather-resistant barrier (WRB). Begin with a horizontal cut along the bottom and the top of the rough opening. Then make a vertical cut in the center from top to bottom. (Fig. 5)
- G) From the exterior, make two diagonal cuts at the top of the "I-Cut" as shown to form a flap. (Fig. 5)
- H) Temporarily tape this top flap up. (Fig. 6)
- I) Fold side flaps into rough opening and secure to inside wall. Cut off excess flap if desired.
- J) Optional cutting patterns for radius and geometric shapes are shown in (Fig. 5b)

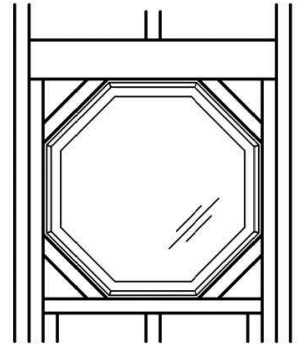
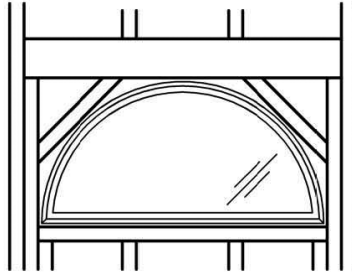
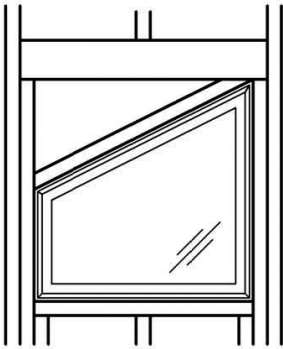

FIG. 3a

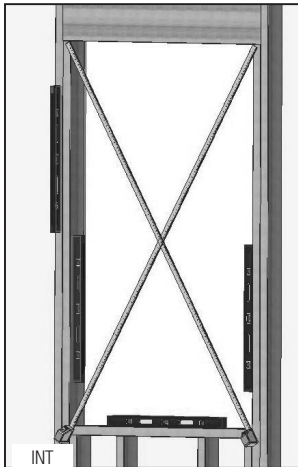

FIG. 4

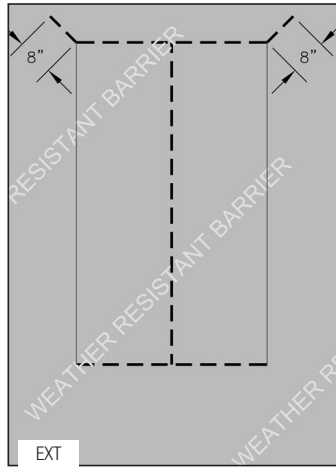

FIG. 5

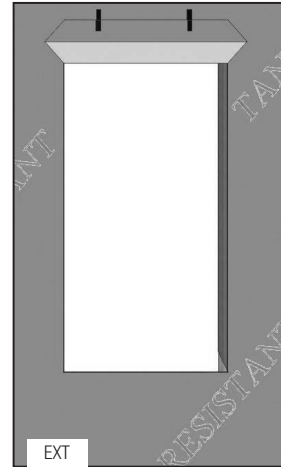

FIG. 6

Step 4: Flashing the Sill

A) IMPORTANT:

- Use flashing that is 6" minimum in width.
- Flashing must meet AAMA-711 performance requirements.
- Adhesive or mechanically-fastened flashing may be used.

B) Measure the width of the rough opening. Cut a length of flashing that is 12" wider than the rough opening. This will allow you to run the flashing 6" up each side. (Fig. 8)

C) Cut 1-1/2" slits at each end of the flashing as shown below. (Fig. 9)

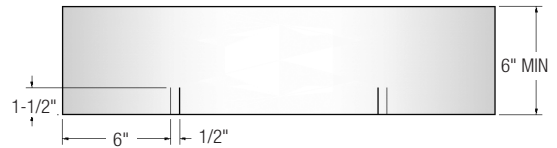

FIG. 7

D) Apply sill flashing to the rough opening as shown below. (Fig. 8)

E) If you are using non-adhesive flashing:

- Staple flashing into place.
- Seal corner notches using 100% neutral cure silicone sealant.

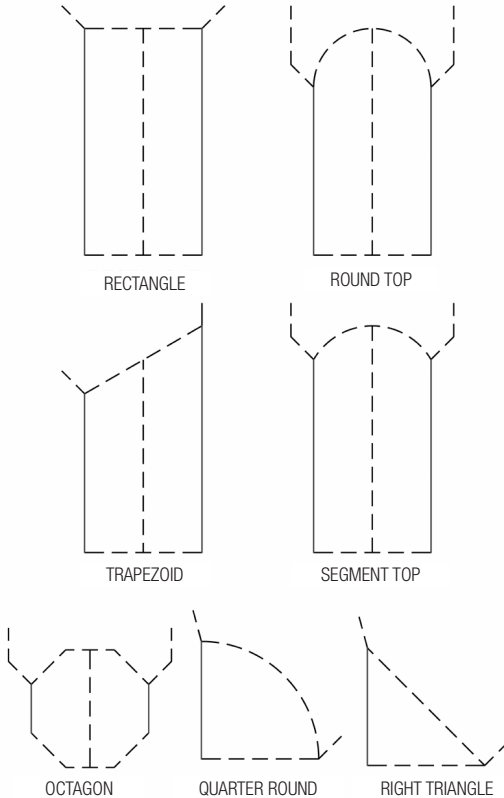

FIG. 5b

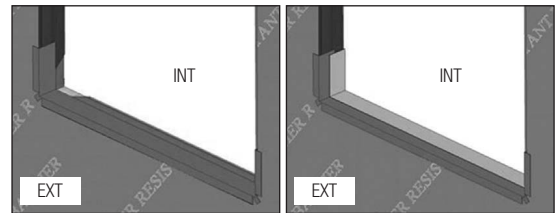

FIG. 8

FIG. 9

F) Flashing must cover the entire sill plate. If needed, apply an additional flashing piece over the first one (*start from the exterior and work toward the interior*). Maintain a minimum 1" overlap. (Fig. 9)

Step 5: Window Installation

For Impact-rated products and/or any products installed in the Florida or Texas TDI regions, supplemental anchoring methods may be required. Refer to supplemental instructions attached to unit or www.windsorwindows.com for further information.

- A) Remove all packaging material (blocks, pads, protectors, stretch wrap).
- B) Inspect and verify the following:
 - a. The window is the correct size and specification.
 - b. The unit is free from any damage or defects.
- C) Contact your nearest Windsor distributor if there are any problems with Step B above.
- D) Apply sealant:
 - a. Apply a 1/4" diameter bead of 100% neutral cure silicone sealant along the backside of the nailing flange.
 - b. Bead must run continuously around both sides and across the head, in line with and completely covering the nailing flange holes. (Fig. 10)
 - c. Use a discontinuous bead at the sill to allow for any drainage. Alternate using a 6" long bead with 1" gaps as shown below. (Fig. 11)
- E) Set the window into the rough opening. Center the unit in the opening, making sure there are equal gaps on both sides of the window.

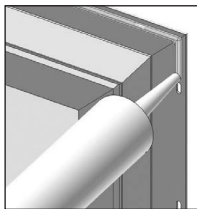

FIG. 10

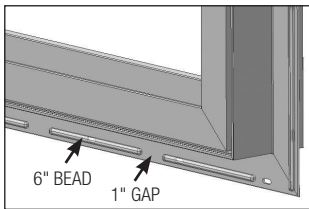
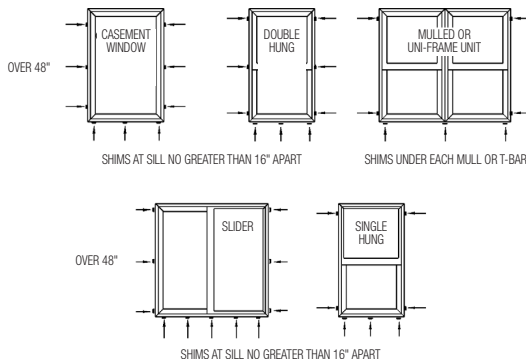

FIG. 11

- F) Temporarily tack the window into place using 2-1/2" galvanized roofing nails through the pre-punched holes on one top corner of the nailing flange. Do not drive the nails in fully.
- G) Shim underneath the window until sill is level. Start with a shim at each corner no more than 1" from jamb corner. Add additional shims spaced evenly from the center of unit, make sure shims are spaced no more than 16" apart. Failure to evenly support sill can result in improper operation and performance and will forfeit the warranty.
- H) Check the unit for square using diagonal measurements. Shim window to ensure the unit is square. Multiple units must have shims under each mull. Casement units over 48" in height must have shims placed at the center to prevent bowing of jambs.
- I) **For double hung units: To ensure proper window operation and performance, it is very important to shim the middle of the unit to obtain equal frame widths as shown.**
- J) Nail all four corners in place through the pre-punched holes in the nailing flange.
- K) Make sure jambs, head and sills are straight. Additional shimming may be required. See below for minimum shim placement.
- L) Finish nailing the window into place through the pre-punched holes in the nailing flange, placing nails within 4" of each corner and no more than 8"-10" in between.



Installation Fasteners

Substrate	Fastener	Type of Steel	Minimum Embedment into Framing
Wood	11 ga. Roofing Nail	Galvanized, Stainless Steel, Zinc Plated	2"
Wood	#8 Wood Screw		2"
Steel	#8 Self Tap/Drill Screw		Fully Threaded

Step 6: Complete Flashing

- Cut and apply side flashing. Side flashing should run from the bottom of the sill flashing to 4" above the rough opening. (Fig. 12)
- If non-adhesive flashing is used, make sure all staple holes are sealed with silicone.
- Cut and apply head flashing. The head flashing should run slightly past the edge of the side flashing as shown. (Fig. 13)
For radius top windows refer to (Fig. 15)
- Flip down the top flap of the WRB.
- Tape the cut seams of the WRB. (Fig. 14)

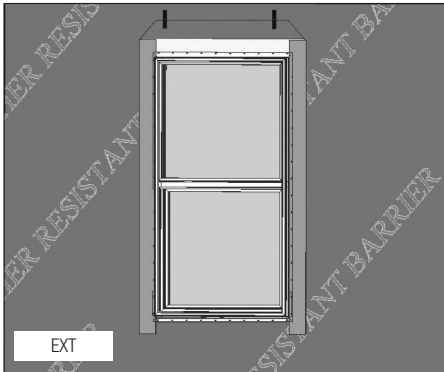

FIG. 12

Step 6: (continued)

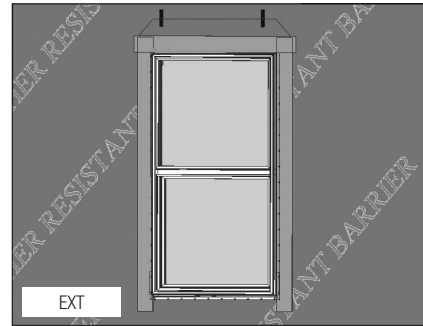

FIG. 13

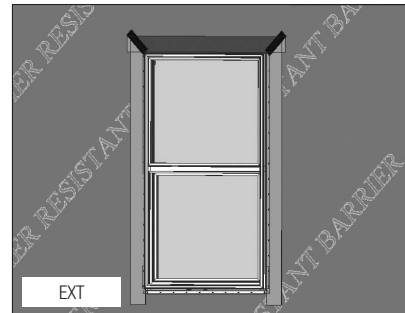

FIG. 14

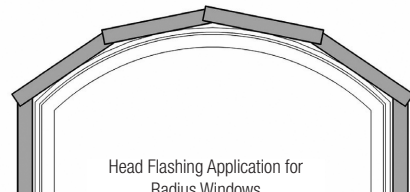

FIG. 15

Step 7: Seal the Exterior

A) **WARNING:** Maintain a minimum of 1/4" between the window frame and any trim, siding or masonry. Failure to do so will forfeit all warranties (written or implied). Windsor Windows & Doors will not be held responsible for any claims or damages resulting from failure to follow these instructions.

B) After siding or wall exterior is complete, apply backer rod and sealant between the window frame and siding material on both sides and sill. Make sure to use 100% neutral cure silicone sealant.

Note: For windows that have an integral J-channel/brickmould frame, this step is not needed when using siding that tucks behind the J-channel/brickmould frame. For windows that utilize a J-channel as an addition to the frame, the backer rod and sealant must be applied between the window frame and the J-channel.

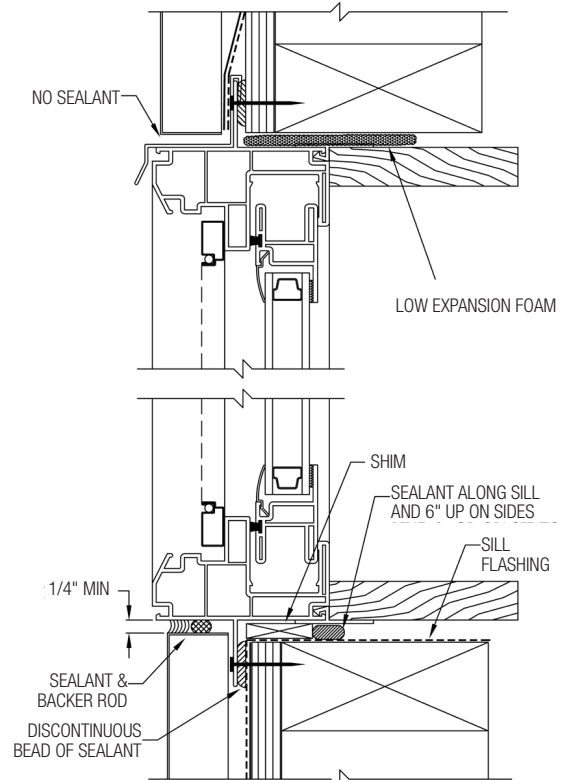
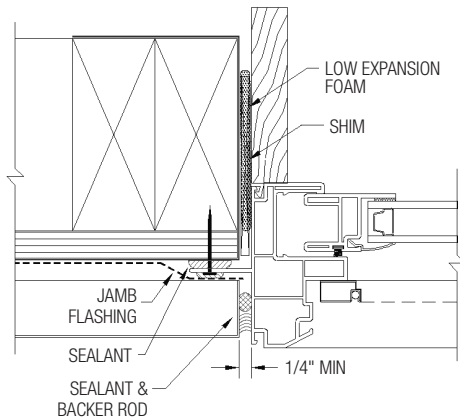

Step 8: Completing the Interior

- A) Install a seal around the full interior perimeter of the opening. On the side jambs and top, apply minimally expanding window and door spray foam insulation. Use caution not to overfill the gap, causing the side jambs to bow. It is not recommended to apply trim to the unit until the foam has cured to allow excess to escape. On the sill, apply a bead of sealant between the sill flashing and the window frame.
- B) Operate window unit to ensure proper operation. Sash will not operate correctly if window is out of square, over-shimmed or over-insulated.
- C) Remove all labels or shipping materials.
- D) Paint or stain all interior wood components.
- **Painting:** Apply primer to unprimed wood surfaces that will be painted. Two coats of high-quality interior trim enamel (latex or oil-based) should be applied in accordance with the paint manufacturer's specifications.
 - **Staining:** Apply stain according to the manufacturer's recommendations. Two coats of high-quality clear finish coat should be applied over any stain.
- E) **IMPORTANT:** Do not stain or paint any vinyl components.

Failure to maintain proper adjustment of casement windows can adversely impact the performance of your windows and may void your warranty.

Casement Windows Operating Sash Adjustment: The sashes of Casement Operating Windows must be adjusted to ensure proper operation and performance. The sashes must be adjusted so the gap between the sash and the frame is consistent. The width of the gaps on the left and right should be similar. The width of the gaps on the top and bottom should be similar. All the gaps should be uniformly straight from one end to another. If you have questions, please see Windsor's Care and Use Guide at www.windsorwindows.com/support/service-information. **CAUTION: Misaligned sash will result in a misaligned seal which will adversely affect the performance of the window. As a result, the failure to maintain proper sash adjustment will void Windsor's warranty.**

To adjust the casement sash, first fully open the window. Next, slip the adjustment wrench (Windsor part number 540036) onto the base of the stud, found between the support arm and the track of the lower hinge. Swinging the wrench away from the lock side of the window will decrease the amount of sash drag.

The maximum adjustment is reached when the stud flats are parallel to the track. Note: Turning the stud flats beyond parallel will not increase adjustment.

For even more adjustment, a similar procedure can be used on the upper hinge. Upper hinge adjustment is made by swinging the wrench toward the lock side of the window. Maximum adjustment is obtained when the stud flats are parallel to the track.

Stud may be adjusted with 3/8" or 7/16" wrench if support arm is removed before adjustment.

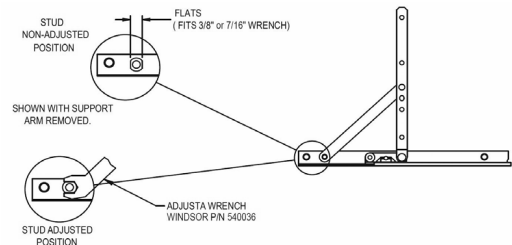

If you have any questions regarding your Windsor Windows, please contact Windsor Windows & Doors directly at 1-800-218-6186. Or you can visit us online at www.windsorwindows.com, where you will find helpful information as well as our Care and Use Guides, which will assist you in preserving your windows and patio doors. While you are at our site, you can also complete and submit the form on the Contact page, and one of our window specialists will promptly answer your question.

Window Opening Control Device

Please check applicable building codes to determine whether a window opening control device is required.

Care and Use

For information about the care and use of your Windsor products, please visit the www.windsorwindows.com/support, and click “Warranty, Care & Installation,” where you will find a link to our Care and Use Guide. Or contact your local independent Windsor distributor and ask for a copy of the Care and Use Guide, which contains information on finishing, cleaning, what to look for during yearly inspections, general maintenance tips, sash/panel adjustment, sash/panel removal, screen removal and information on condensation. You should inspect your windows at least annually.

Warranties

You can find a copy of our current Warranty at the website, under the “Support” tab. If you have Windsor products that are older, please contact Windsor at 1-800-218-6186, and we will provide a copy of the applicable warranty.



www.windsorwindows.com